

DG Series

7-30W LED Downlight

Tilttable anti-glare COB led downlight

BESUN DG series tilttable anti-glare COB led downlight , the lowest UGR can be 9, suitable for various places which with very low UGR requirements.

DG Series;
Patented designs (6 patents)

Support almost all the famous light source;
Perfectly compatible with the same light fixture, same size, but different light source.

Completely free solder assembling;
Replace any accessories perfectly without Soldering Tools

Perfect secondary optical design;
Beautiful light spot for wide/medium/small beam angle.

IP33

Greatly enhance the cold lumens;
135lm/W under CRI>90 & 3000K.

Non-flicker Driver;
Support Triac dim; 1-10V dim; Dali dim; Wifi dim, etc.

5 years warranty

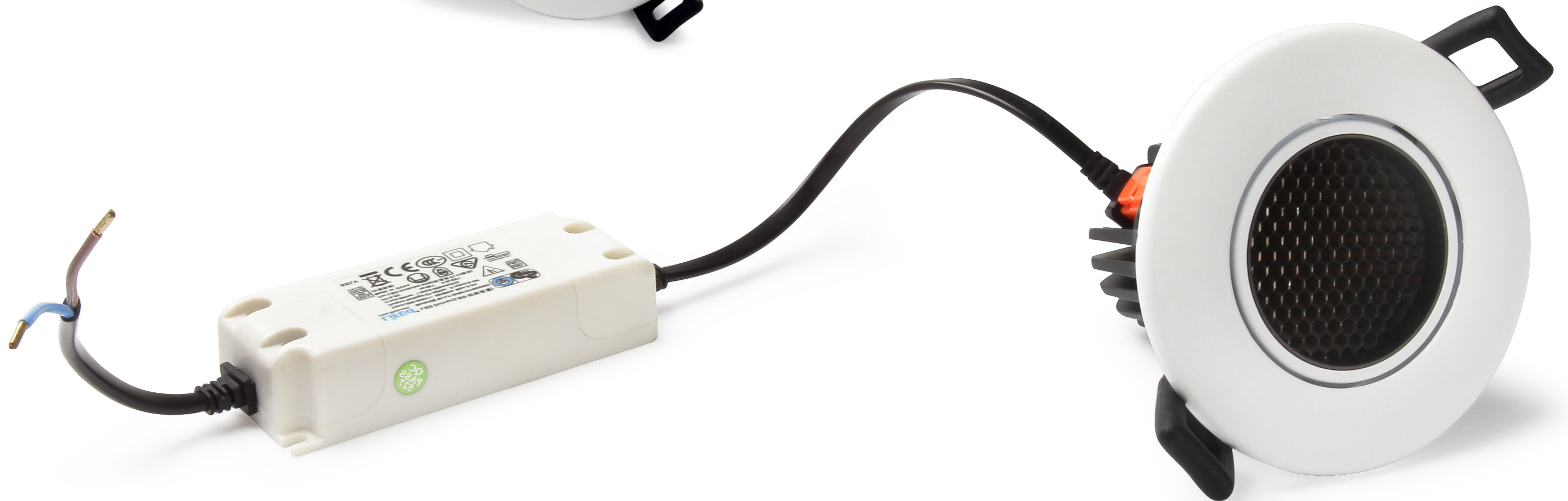
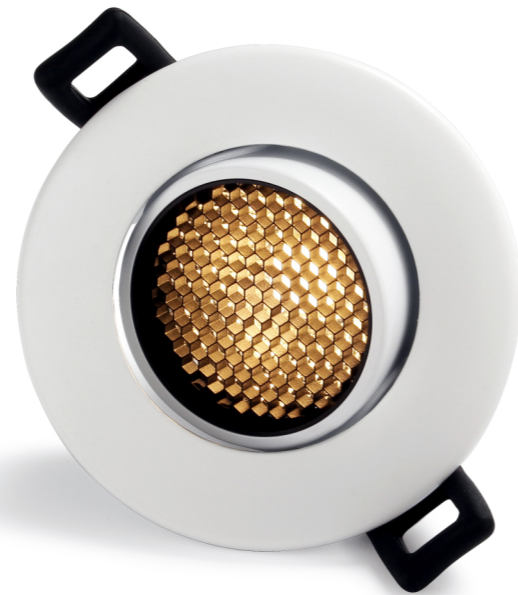
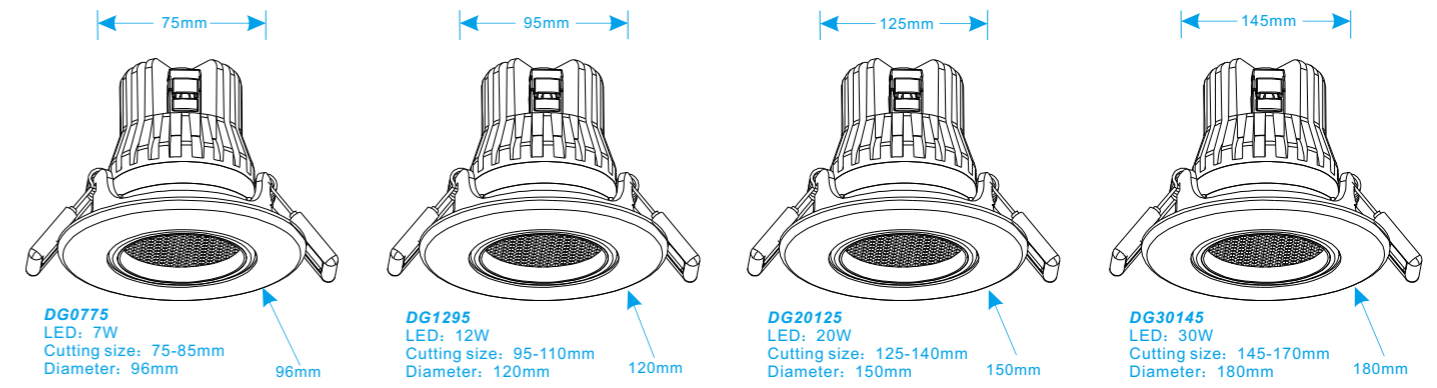

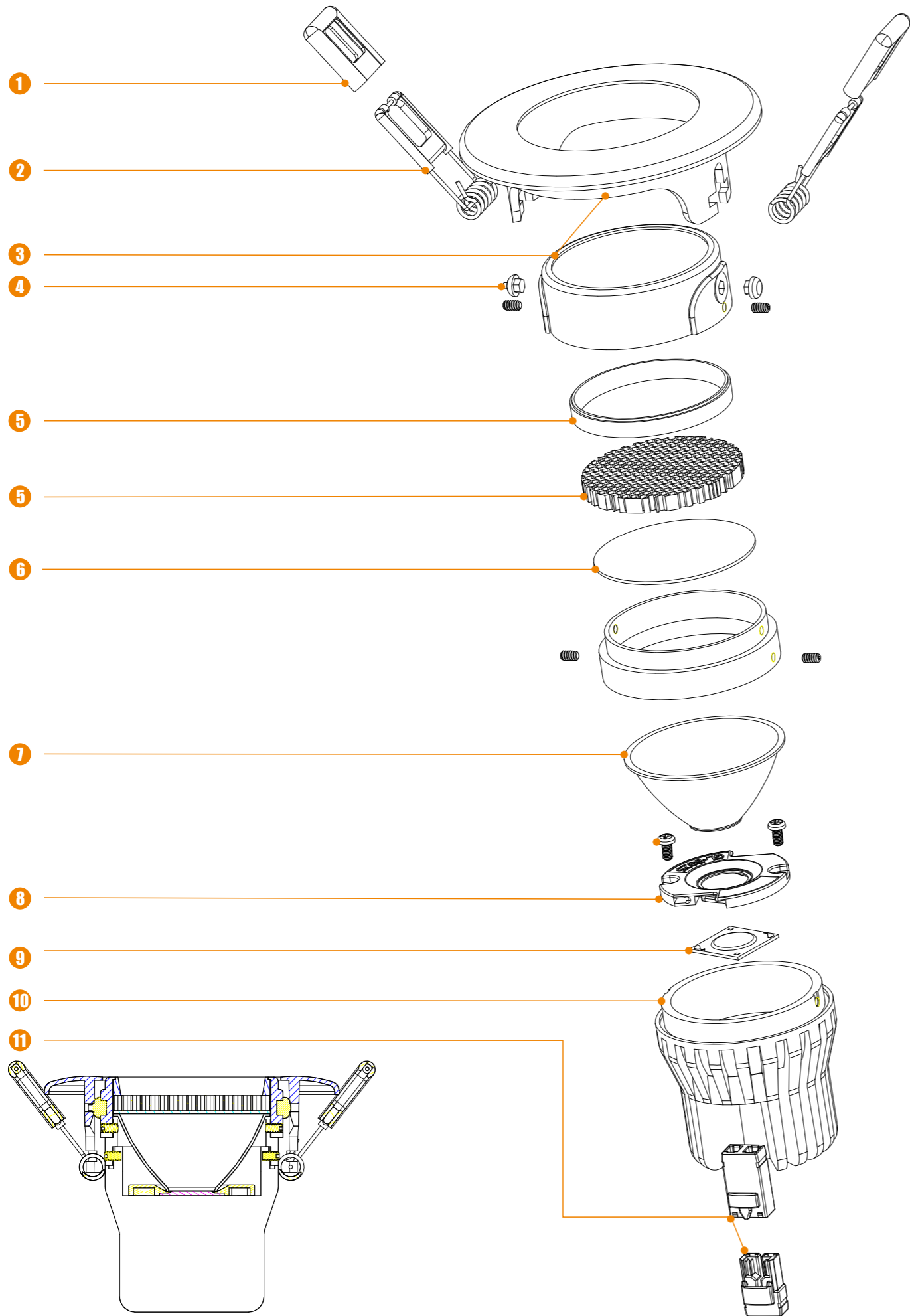

LED DOWNLIGHT DG

1 Silicone spring cover to protect hands and paint



2 High-performance springs has passed salt spray test, corrosion resistance test, and anti-decay, ensure no deformation in 10 years.



3 Various color housing optional: white, silver, black, golden, etc.



4 Special axle design: It can be easily rotated (around 30deg) once lightly pushed, which is different from the traditional screw rotation. Rotation lifespan is about 200 times.



5 Anti-glare components

6 Full tempered glass, even if broken, it will not endanger your safety. Optional glass: clear glass, frosted glass, middle-frosted glass.



7 Pure aluminum reflective cup, anodizing, anti-corrosiveness and anti-aging, which is different from electroplating plastic cup. Optional beam angle : 15°-110°

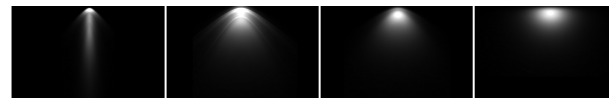

8 Free soldering LED connector (patented design)



9 Optional LED



10 The passive radiator with superior heat dissipation under -40-55°C working environment. (L-80 temperature measuring point of light source is 25°C, 65°C and 85°C)

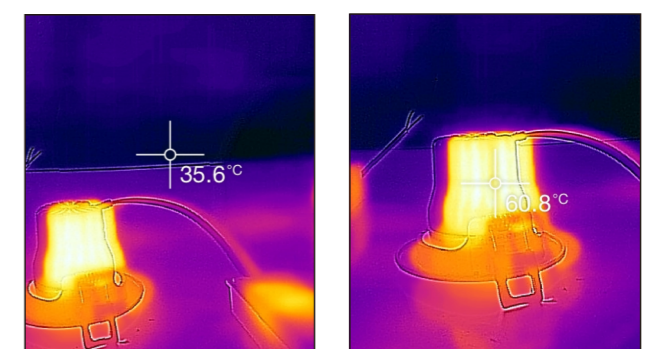

11 Recessed anti-pull-off connector (patented design)

Recessed connector design ensure the maximum installation space of the lamp, The connector deviate less than 1.5mm under 10r pull; the lamp and driver can be easily connected or replaced without soldering.



LED DOWNLIGHT DG

7W COB LED DOWNLIGHT



DG0775S

NETWEIGHT	0.34 Kg	CUTTINGSIZE	75-85mm	PACKING	10.5x10.5x11.5CM 1 pc	PACKING	43.5x43.5x36.5CM 48 pcs
------------------	---------	--------------------	---------	----------------	-----------------------	----------------	-------------------------



BESUN DG series tiltable anti-glare COB led downlight , the lowest UGR can be 9, suitable for various places which with very low UGR requirements.

- **Support almost all the famous light source;**
Perfectly compatible with the same light fixture, same size, but different light source.
- **Completely free solder assembling;**
Replace any accessories perfectly without Soldering Tools
- **Perfect secondary optical design;**
Beautiful light spot for wide/medium/small beam angle.
- **Physically waterproof and dustproof;**
The highest IP rating reaches IP33
- **Greatly enhance the cold lumens;**
136lm/W under CRI>90 & 3000K.
- **Non-flicker Driver;**
Support Triac dim; 1-10V dim; Dali dim; Wifi dim, etc.
- **5 years warranty**

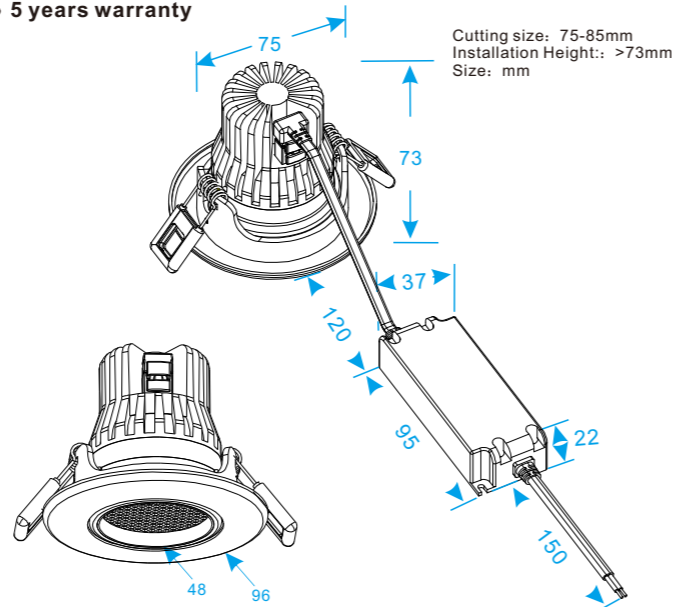

Application:
DG series downlights are widely used as indoor main illumination lighting in household, hotel, restaurant, shopping mall, bar, KTV, cabinet, office, meeting room, library, museum, exhibition etc...

● Standard ○ Optional — Unsupported “E” Economy type “S” Standard type

LED	BESUN	BESUN	CREE	CITIZEN				
Brand	● B20151305(S) ○ B20151307(M)	B20151202(E)	● CXA1507	● 026-1202C1				
PCB	ceramic	ceramic	ceramic	aluminum				
CRI	● 90 R9>50 ○ other	● 90 R9>50 ○ other	● 80 R9>0 ○ 90 R9>50	● 90 R9>50 ○ other				
Power(W)	7	7	7	7				
Voltage(V)	36V	36V	34.6V	36V				
Features	135lm/w	114lm/w	CREE	116lm/w				
CCT;LM/W 27=2700K 35=3500K	CCT	LM/W	CCT	LM/W	CCT	LM/W	CCT	LM/W
	● 27	126	○ 27	105	● 27	120	● 27	111
	● 30	135	○ 30	114	● 30	120	● 30	116
	● 40	144	● 40	122	○ 35	130	○ 35	119
	○ 50	148	○ 50	125	● 40	130	● 40	120
	○ 60	150	○ 60	123	○ 50	130		
	○ other	CRI>90	○ other	CRI>90	○ other	CRI>80		CRI>90

LED chip quantity	● 13*5 ○ 13*7	12*2	12*2	12*2	12*2
Certificates	L-80	-	L-80	L-80	L-80
Current Rating(mA)	200				
SDCM	<4				

● Standard ○ Optional — Unsupported “E” Economy type “S” Standard type

Driver	NO-DIM	DIM	Dali/Push-Dim	1-10V/Push-Dim	WiFi (intelligent)
Brand	Lifud(S) ● 200-240VAC GIR010YS ○ 100-277VAC GIR007YA	Eaglerise(S) ● 200-240VAC ELP009C0200LSD1	Easeic ● 100-240VAC LND118	Easeic ● 100-240VAC LNA118	LTECH ● 12-48VDC WiFi104 R4-5A R4-CC T1 T2 T2M T3 T3M
	Eaglerise(E) ○ 200-240VAC EIP009C0200LSS	Eaglerise(E) ○ 200-240VAC EIP009C0200LSD1L			
DC Output	27-42V/200mA	27-42V/200mA	27-42V/180mA	27-42V/180mA	12-48V 1-1400mA
PF/PE	GIR010YS 0.95/83% GIR007YA 0.95/80% EIP009C0200LSS 0.5/84%	ELP009C0200LSD1 0.95/80% EIP009C0200LSD1L 0.95/80%	0.9/80%	0.9/80%	/
Flickering	GIR010YS NO GIR007YA yes EIP009C0200LSS NO	ELP009C0200LSD1 NO EIP009C0200LSD1L yes	yes	yes	/
Certificates	GIR10YS(A)	ELP009C0200LSD1	LND118	LNA118	/
	CE CB GS RCM SAA CCC	CE SAA			
	GIR007YA	-			
	CE	-	CE CUL SAA	CE CUL SAA	CE ROHS FCC
	EIP009C0200LSS	EIP009C0200LSD1L			
CE TUV BIS	TUV CE SAA				

● Standard ○ Optional The lamp working voltage with different light source is corresponds to the driver working voltage

Lamp	BESUN	BESUN	CREE	CITIZEN								
Item No.	DG0775S	DG0775E	DG0775S	DG0775S								
Warranty	5 years	3 years	5 years	5 years								
System Consumption(W)	8.5	8.5	8.5	8.5								
Beam Angle	20°	20°	15°	15°								
UGR	10-13	10-13	9-12	9-10								
Soldering technology	Free soldering	Free soldering	Free soldering	Free soldering								
Certificates	CE RoHS FCC V0 ERP LM-79	CE RoHS FCC V0	CE RoHS FCC V0 ERP LM-79	CE RoHS FCC V0 ERP LM-79								
Working environment	-40°-55°											
IP grade	IP33											
Color of Housing	● W OS OB OV											
optical data	.IES/.CIE/.CEN/.Tm14/.CIB/.LDT											
System lm/w 30=3000K 35=3500K	CCT	LM	20°	CCT	LM	20°	CCT	LM	15°	CCT	LM	15°
	● 27	260	○ 27	220	● 27	310	● 27	280				
	● 30	280	● 30	240	● 30	320	● 30	290				
	● 40	290	● 40	270	○ 35	330	○ 35	300				
	○ 50	300	○ 50	270	● 40	340	● 40	340				
	○ 60	290	○ 60	260	○ 50	340						
	○ other	CRI>90	○ other	CRI>90	○ other	CRI>80		CRI>90				

BESUN LED Standard

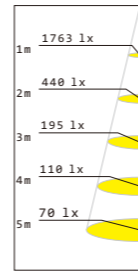
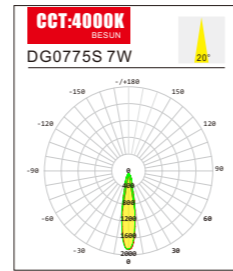
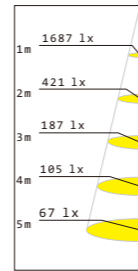
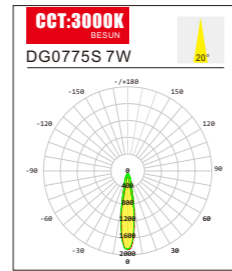
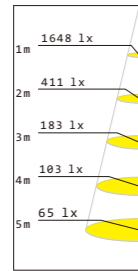
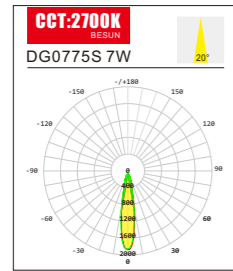

CREE LED Standard

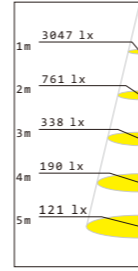
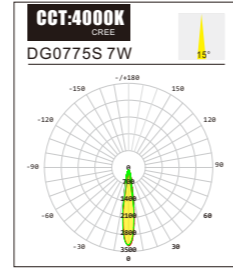
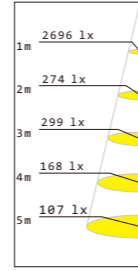
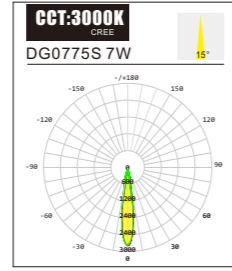
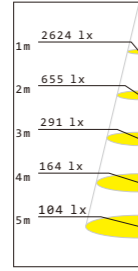
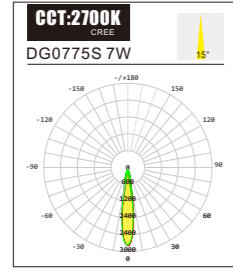

CITIZEN LED Standard

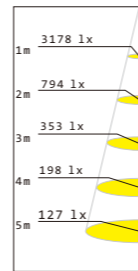
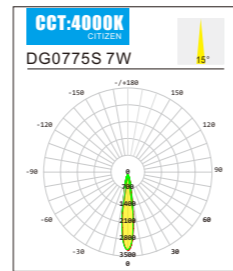
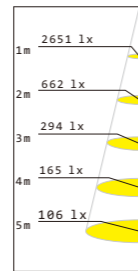
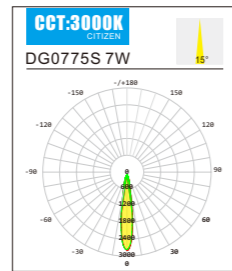
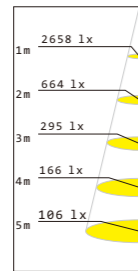
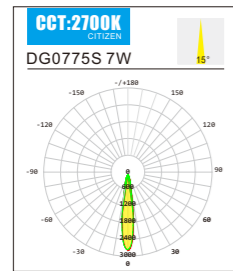

CCT/Parameters	BESUN DG0775S	BESUN DG0775E	CREE DG0775S	CITIZEN DG0775S	
2700K	Angle(°)	20°	20.1°	17.5°	15.9°
	RA	>90	>90	>80	>90
	LM	262	225	314	292
	UGR	12.6	12.5	11	9.4
3000K	Angle(°)	19.6°	20.2°	17.3°	16.1°
	RA	>90	>90	>80	>90
	LM	281	243	320	291
	UGR	13.1	12.4	9	9
4000K	Angle(°)	20.4°	20.5°	17.1°	15.9°
	RA	>90	>90	>80	>90
	LM	297	273	346	341
	UGR	11.6	11.5	10.8	9.1
5000K	Angle(°)	20.7°	19.9°	-	-
	RA	>90	>90	-	-
	LM	299	278	-	-
	UGR	10.3	11.6	-	-
6000K	Angle(°)	19.9°	20.3°	-	-
	RA	>90	>90	-	-
	LM	290	266	-	-
	UGR	11.4	12.3	-	-

Triac dimmer compatibility

Brand	Item No.	picture
CLIPSAL	32E450UDM 220-240VAC 50Hz MAX:450W	
CLIPSAL	32E450ULM 220-240VAC 50Hz MAX:450W	
JUNG	225NV DE 220-240VAC 50Hz MAX:20-500W	
GIRA	226200/I01 220-240VAC 50Hz MAX:20-500W	
BERKER	2873 220-240VAC 50Hz MAX:20-500W	

12W COB LED DOWNLIGHT



DG1295S

NETWEIGHT	CUTTINGSIZE	PACKING	PACKING
0.5 Kg	95-105mm	12.5x12.5x12.5CM 1 pc	51.5x39.0x39.5CM 36 pcs



BESUN DG series tiltable anti-glare COB led downlight , the lowest UGR can be 9, suitable for various places which with very low UGR requirements.

- **Support almost all the famous light source;**
Perfectly compatible with the same light fixture, same size, but different light source.
- **Completely free solder assembling;**
Replace any accessories perfectly without Soldering Tools
- **Perfect secondary optical design;**
Beautiful light spot for wide/medium/small beam angle.
- **Physically waterproof and dustproof;**
The highest IP rating reaches IP33
- **Greatly enhance the cold lumens;**
131lm/W under CRI>90 & 3000K.
- **Non-flicker Driver;**
Support Triac dim; 1-10V dim; Dali dim; Wifi dim, etc.
- **5 years warranty**

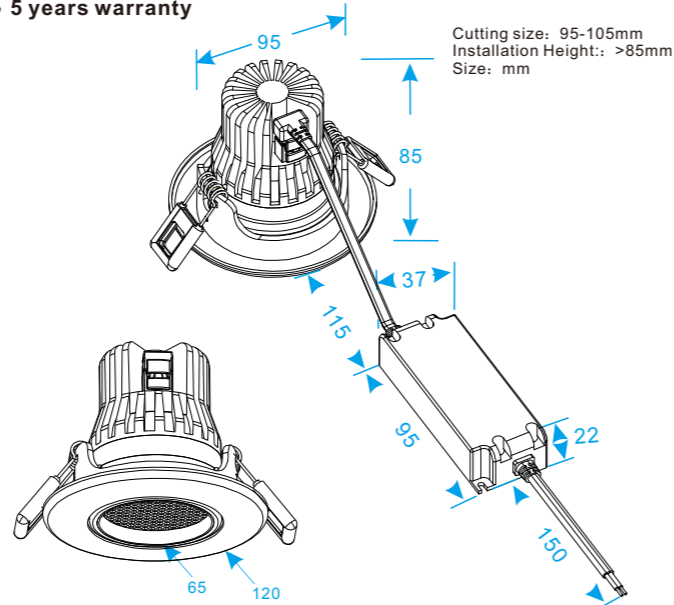

Application:
DG series downlights are widely used as indoor main illumination lighting in household, hotel, restaurant, shopping mall, bar, KTV, cabinet, office, meeting room, library, museum, exhibition etc...

● Standard ○ Optional — Unsupported “E” Economy type “S” Standard type

LED	BESUN	BESUN	CREE	CITIZEN	SHARP
Brand	● B20151204(S)	● B20151204(E)	● CXA1512	● 026-1204C4	GW6NGWJCSOC
PCB	ceramic	ceramic	ceramic	aluminum	ceramic
CRI	● 90 R9>50 ○ other	● 90 R9>50 ○ other	● 80 R9>0 ○ 90 R9>50	● 90 R9>50 ○ other	● 95 R9>90
Power(W)	12	12	12.6	12	0.5-12
Voltage(V)	35V	35V	36V	35V	35V
Features	131lm/w	114lm/w	CREE	117lm/w	CCT Dimmable
CCT;LM/W 27=2700K 35=3500K	CCT LM/W	CCT LM/W	CCT LM/W	CCT LM/W	CCT LM/W W
	● 27 116	○ 27 112	● 27 123	● 27 115	● 20 69 1.5w
	● 30 131	● 30 114	● 30 134	● 30 117	● 25 80 3.3w
	● 40 136	● 40 124	○ 35 134	○ 35 117	● 27 84 4.9w
	○ 50 142	○ 50 126	● 40 134	● 40 139	● 30 80 12w
	○ 60 140	○ 60 122	○ 50 134		
○ other CRI>90	○ other CRI>90	○ other CRI>80	CRI>90	CRI>95	

LED chip quantity	12*4	12*4	12*3	12*4	12*2
Certificates	L-80	-	L-80	L-80	L-80
Current Rating(mA)	350				
SDCM	<4				

● Standard ○ Optional — Unsupported “E” Economy type “S” Standard type

Driver	NO-DIM	DIM	Dali/Push-Dim	1-10V/Push-Dim	WiFi (intelligent)
Brand	● Lifud(S) ● 200-240VAC GIR015YS ○ 100-277VAC GIR020Yk	● Eaglerise(S) ● 200-240VAC ELP012C0350LSD1	● Easeic ● 100-240VAC LND118	● Easeic ● 100-240VAC LNA118	● LTECH ● 12-48VDC WiFi104R R4-5A R4-CC T1 T2 T3 T3M
	○ Lifud(E) ○ 200-240VAC GIR013YS0350H	○ Eaglerise(E) ○ 200-240VAC EIP012C0350LSD1L			
DC Output	27-42V/350mA	27-35V/350mA	27-42V/350mA	27-42V/350mA	12-48V 1-1400mA
PF/PE	GIR015YS 0.95/85% GIR020YK 0.95/85% GIR013YS0350H 0.45/82%	ELP012C0350LSD1 0.95/80% EIP012C0350LSD1L 0.95/80%	0.9/80%	0.9/80%	/
Flickering	GIR015YS NO GIR020YK yes GIR013YS0350H NO	ELP012C0350LSD1 NO EIP012C0350LSD1L yes	yes	yes	/
Certificates	GIR015YS(A)	ELP012C0350LSD1	LND118	LNA118	/
	CE CB GS RCM SAA CCC	CE SAA			
	GIR020YK	EIP012C0350LSD1L	CE CUL SAA	CE CUL SAA	CE ROHS FCC
	CE CB GS				
	GIR013YS0350H	TUV CE			

● Standard ○ Optional The lamp working voltage with different light source is corresponds to the driver working voltage

Lamp	BESUN	BESUN	CREE	CITIZEN
Item No.	DG1295S	DG1295E	DG1295S	DG1295S
Warranty	5 years	3 years	5 years	5 years
System Consumption(W)	14	14	14.5	14
Beam Angle	20°	20°	15°	15°
UGR	9-10	10-11	9	9
Soldering technology	Free soldering	Free soldering	Free soldering	Free soldering
Certificates	CE RoHS FCC V0 ERP LM-79	CE RoHS FCC V0	CE RoHS FCC V0 ERP LM-79	CE RoHS FCC V0 ERP LM-79
Working environment	-40°-55°			
IP grade	IP33			
Color of Housing	● W OS OB OV			
optical data	.IES/.CIE/.CEN/.Tm14/.CIB/.LDT			
System lm/w 30=3000K 35=3500K	CCT LM 18°	CCT LM 18°	CCT LM 15°	CCT LM 15°
	● 27 585	○ 27 566	● 27 741	● 27 622
	● 30 660	● 30 590	● 30 793	● 30 665
	● 40 715	● 40 648	○ 35 793	○ 35 670
	○ 50 703	○ 50 643	● 40 795	● 40 794
	○ 60 689	○ 60 619	○ 50 800	
○ other CRI>90	○ other CRI>90	○ other CRI>80	CRI>90	

BESUN LED Standard

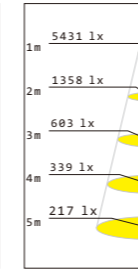
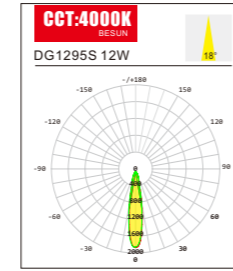
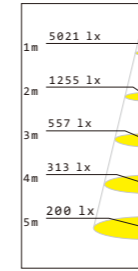
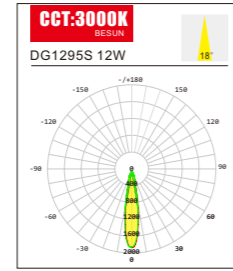
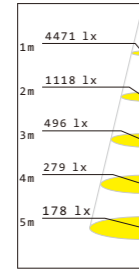
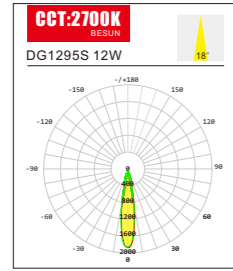

CREE LED Standard

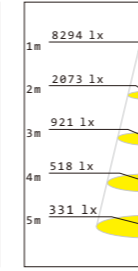
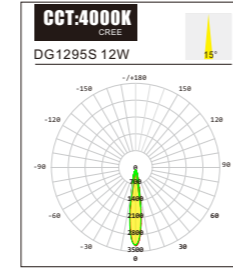
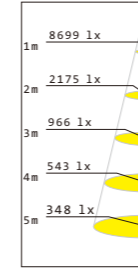
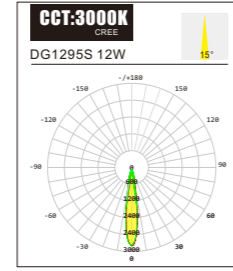
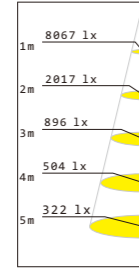
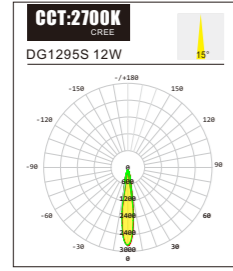

CITIZEN LED Standard

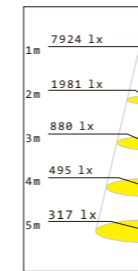
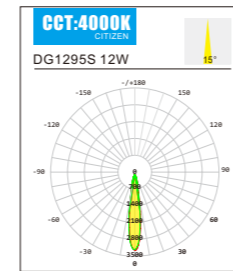
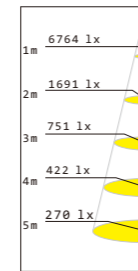
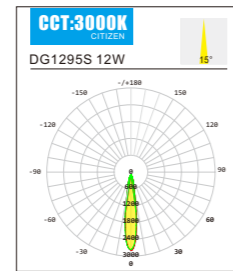
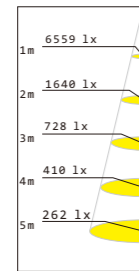
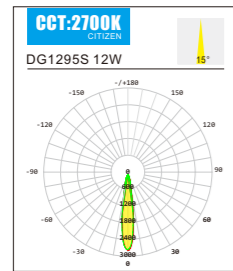

CCT/Parameters	BESUN DG1295S	BESUN DG1295E	CREE DG1295S	CITIZEN DG1295S
2700K	Angle(°)	17.7°	17.2°	14.2°
	RA	>90	>90	>90
	LM	585	566	741
	UGR	9.7	10.2	7.4
3000K	Angle(°)	17.6°	17.2°	14°
	RA	>90	>90	>90
	LM	660	590	793
	UGR	9.6	10	8.7
4000K	Angle(°)	17.6°	17.2°	14.4°
	RA	>90	>90	>90
	LM	715	648	778
	UGR	9.1	10.1	8
5000K	Angle(°)	17.6°	17.3°	-
	RA	>90	>90	-
	LM	703	643	-
	UGR	10	9.1	-
6000K	Angle(°)	17.3°	17.6°	-
	RA	>90	>90	-
	LM	689	619	-
	UGR	9.1	10.8	-

Triac dimmer compatibility

Brand	Item No.	picture
CLIPSAL	32E450UDM 220-240VAC 50Hz MAX:450W	
CLIPSAL	32E450ULM 220-240VAC 50Hz MAX:450W	
JUNG	225NV DE 220-240VAC 50Hz MAX:20-500W	
GIRA	226200/101 220-240VAC 50Hz MAX:20-500W	
BERKER	2873 220-240VAC 50Hz MAX:20-500W	